

U5000AT⁺ and U6000AT⁺ Ultrasonic Nebulizers



U5000AT⁺ Ultrasonic Nebulizer



U6000AT⁺ Ultrasonic Nebulizer with
Membrane Desolvator

OPERATOR'S ACCESSORIES AND PARTS CATALOG

U5000AT+ and U6000AT+ Ultrasonic Nebulizers Spare Parts and Supplies Catalog

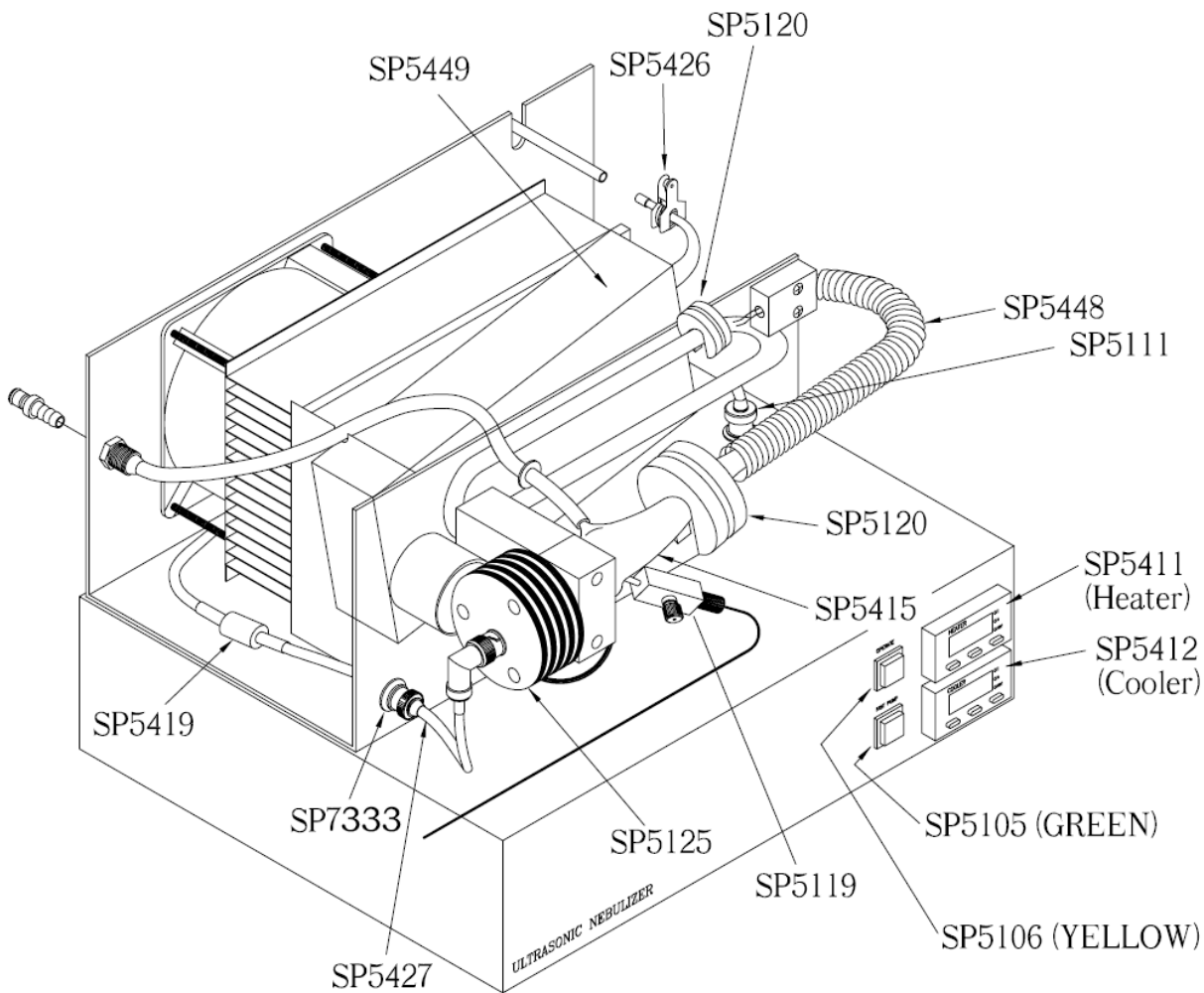

U5000AT+ and U6000AT+ Ultrasonic Nebulizers Spare Parts and Supplies Catalog



One Year Consumable Kit for U5000AT+ and U000AT+ SP7679

Kit Contains: One transducer assembly, a fuse kit, a set of drain pump tubing, an Argon flow restrictor, two PEEK sample inlet tubes with uptake tubing and peristaltic pump tubing, and all drain and rinse tubing for the system.



Fuse Kit SP5410



Temperature Controller, Heater SP5411

(Also used on membrane desolvator for U6000AT+)



Temperature Controller, Cooler SP5412











Drain Pump Kit SP5431

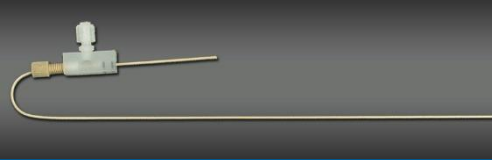

Drain Pump Head Assembly SP5122C

U5000AT⁺ and U6000AT⁺ Ultrasonic Nebulizers Spare Parts and Supplies Catalog

	<p>Aerosol (Spray) Chamber Kit</p>	<p>SP5415</p>
	<p>Heated J-Tube Assembly</p>	<p>SP5448</p>
	<p>Cooler Assembly</p>	<p>SP5449</p>
	<p>12/5 Glass Socket Adapter</p>	<p>SP5160</p>
	<p>Clamp for 12/5 Glass Socket Adapter</p>	<p>SP5426</p>
	<p>Ball Joint Clamp Kit (Includes clamps for both ends of the Heated J-Tube Assembly)</p>	<p>SP5120</p>
	<p>Sample Inlet Adapter Assembly (Includes Adapter and PEEK Tubing)</p>	<p>SP5119</p>
	<p>Spare Transducer Assembly With spare O-ring</p>	<p>SP5125</p>

U5000AT+ and U6000AT+ Ultrasonic Nebulizers Spare Parts and Supplies Catalog

	Transducer cable	SP5427
	Circuit Breaker, 2 amp	SP5153
	Argon-In Connector Kit	SP5413
	Argon in Flow Restrictor 500 mL / min (blue color band)	SP5156
	Argon in Flow Restrictor 1000 mL / min (red color band)	SP5156B
	Hex (Allen) Wrench	SP5172

U5000AT+ and U6000AT+ Ultrasonic Nebulizers Spare Parts and Supplies Catalog



U-5000 AT+ Glassware Module Cover

SP5451

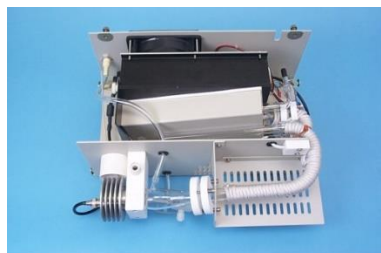

Glassware Module

SP5409



Electronics Module

100/115 V

SP5422

200/240 V

SP5423

Tubing and O-Ring Kits



Spare Parts Kit. Includes Each of the Following:

SP5447



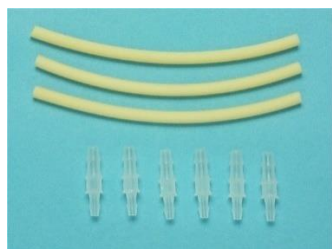



Sample inlet tubing, sample out tubing, rinse tubing, drain tubing, sample inlet peristaltic pump tubing (package of 12 each), drain peristaltic pump tubing, and aerosol chamber O-ring



Drain Pump Tubing and Connector Kit

SP5366

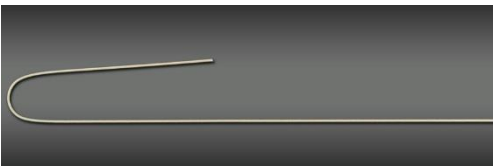
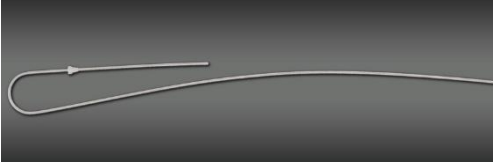
U5000AT⁺ and U6000AT⁺ Ultrasonic Nebulizers Spare Parts and Supplies Catalog

	<p>Acid proof O-ring Kit.</p> <p>Contains Aerosol Chamber O-ring and J-Tube Ball Joint O-rings</p>	<p>SP5126</p>
	<p>Aerosol chamber O-ring (2 per kit):</p>	<p>SP5168B</p>
	<p>Sample Uptake Peristaltic Pump Tubing, gray/gray color code, 1.3 mm I.D. (12 per package)</p>	<p>SP5136</p>
	<p>FEP Sample Inlet Tubing</p> <p>1.6 mm O.D. x 0.8 mm I.D., 25 ft. (7.6m)</p>	<p>SP5150A</p>
	<p>PEEK Sample Inlet Tubing.</p> <p>Used with rectangular PCTFE adapters. (1.6 mm O.D. x 0.5 mm I.D. x 45.7 cm long)</p>	<p>SP5150B</p>
	<p>ETFE Sample Inlet Tubing for Higher Conc. (> 10%) Acid Samples</p> <p>To be used instead of PEEK sample inlet tubing normally supplied with unit (1.6 mm O.D. x 0.5 mm I.D. x 45.7 cm long)</p>	<p>SP5151</p>
	<p>Tubing Cutter (includes cutting blade)</p>	<p>SP5170</p>

U5000AT⁺ and U6000AT⁺ Ultrasonic Nebulizers Spare Parts and Supplies Catalog

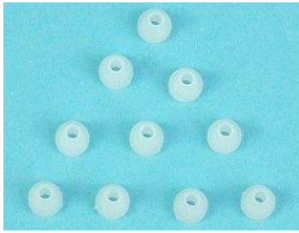

Ferrule Replacement Kit for Sample
Inlet Tube (10 ferrules per kit)

SP6007



Extension Tubing Kit.

SP5154

Contains 3 ft. (0.9 m) of ETFE tubing with
connector

Can be used with PEEK sample inlet tubing
normally supplied with unit or ETFE sample inlet
tubing.



Sample Out Tubing Kit.

SP5159

Contains 5 ft. (1.5 m) of Tygon tubing, 5/16 in.
O.D. x 3/16 in. I.D.

U5000AT+ and U6000AT+ Ultrasonic Nebulizers Spare Parts and Supplies Catalog

ICP Adapters



Torch Adapter, PerkinElmer/Sciex ELAN 5000, 6000, 6100, 9000 ICP-MS SP5167

NOTE: ELAN 6100DRC requires SP5160



Torch Adapter, 12/5 glass socket SP5160

Use for: GBC, Horiba JY, Leeman, Seiko, Shimadzu, PerkinElmer Avio 200, and Agilent 5100 series ICP-AES

Agilent 4500/7500/7700/7900/8800, Nu Instruments, PerkinElmer ELAN DRC & NexION Series, Thermo X Series II, Thermo Element 1 and 2, Thermo Neptune, and Analytik Jena (ex. Bruker Varian) ICP-MS

Agilent 4100/4200 MP-AES



Torch Adapter, 18/9 Glass Socket SP5161

Use for Spectro ICP-AES



Torch adapter, all Jobin Yvon (JY) radial-viewing ICP-AES instruments produced since 1990 SP5163

U5000AT+ and U6000AT+ Ultrasonic Nebulizers Spare Parts and Supplies Catalog



Torch Adapter, Agilent (ex. Varian) Vista and ES-700 Series ICP-AES SP5166A



Torch Adapters, PerkinElmer Optima 3000 Series Axial and Dual-Viewing ICP-AES: SP6003

Optima 3000XL, Optima 3000SC(X)
Optima 3000SC(DV), Optima 3100XL or DV,
Optima 3200XL or DV, Optima 3300XL or DV



Torch Adapter, PerkinElmer Optima 2000/4000/5000/7000/8000 Series ICP-AES instruments SP6005



Torch Adapter, TJA 61E/ Atomscan / Trace Analyzer / Trace 61E/ IRIS Advantage / IRIS Intrepid /Thermo iCAP 6000 & 7000 Series ICP-AES SP6006

Interface Kits



Interface kit for all Spectro ICP-AES (Genesis, Arcos, Spectroblue) and Spectro MS ICP-MS SP5155P



Interface kit for Agilent 4500/7500/7700/7900/8800 ICP-MS, Agilent 5100 Series ICP-AES, Thermo X Series II ICP-MS, Analytik Jena PlasmaQuad PQ 9000 ICP-AES SP5155Y



Interface kit for all radial-viewing Horiba JY ICP-AES instruments SP5155F

U5000AT+ and U6000AT+ Ultrasonic Nebulizers Spare Parts and Supplies Catalog



Interface kit for PerkinElmer Optima 3000XL, Optima 3000SC(X), Optima 3000SC(DV), Optima 3100XL or DV, Optima 3200XL or DV, and Optima 3300XL or DV ICP-AES instruments

SP5155BB



Interface kit for TJA 61E / Atomscan Advantage / Trace Analyzer / Trace 61E / IRIS Advantage / IRIS Intrepid / Thermo iCAP 6000/7000 Series ICP-AES

SP5155CC



Interface kit for Teledyne Leeman Prodigy, Profile, and Prism ICP-AES

SP5155I



Interface kit for Agilent (Ex-Varian) Liberty, Vista, and ES-700 Series ICP-AES, Agilent 4100/4200 MP-AES

SP5155S



Interface kit for all PerkinElmer ELAN and NexION Series ICP-MS, Optima 2000/4000/5000/7000/8000 Series ICP-AES and Avio 200 ICP-AES

SP5155L

U5000AT+ and U6000AT+ Ultrasonic Nebulizers Spare Parts and Supplies Catalog

	Interface kit for Seiko ICP-AES instruments	SP5155O
	Interface kit for all Shimadzu ICP-AES instruments	SP5155Z
	Interface kit for Thermo Element 1 and 2 HR-ICP-MS, and Thermo Neptune MC-ICP-MS	SP5155EE
	Interface kit for GBC Integra and Quantima ICP-AES, and Optimass Series ICP-MS	SP5155G

Ordering

To order, contact:

Phone (Toll-Free, USA): 800-369-2822

Phone (Outside USA): +1-402-733-2829

e-mail: cetacsales@teledyne.com

www.teledynecetac.com

Teledyne CETAC Technologies

14306 Industrial Road

Omaha, Nebraska 68144, USA

For questions about service and repair, call us at the numbers above or e-mail cetacs-service@teledyne.com

Trademark Acknowledgements: Tygon and Tygon S3 are registered trademarks of Saint-Gobain Performance Plastics.